

Plan

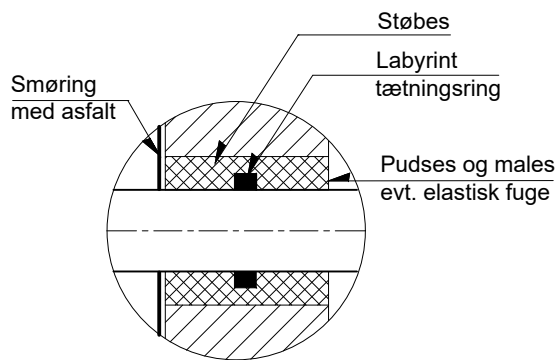

Detailje 1

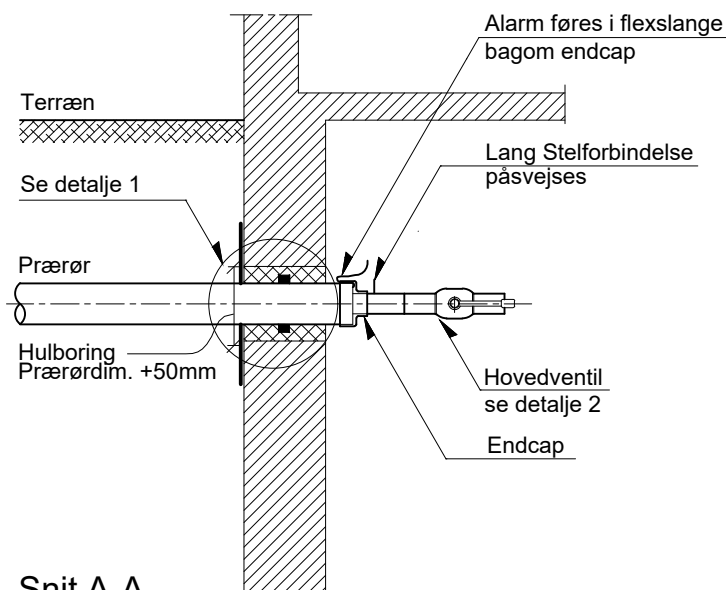

Snit A-A

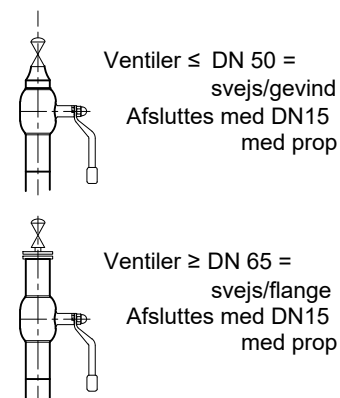

Design tryk	Flange PN
6	25
10	25
16	25
25	40

Detailje 2

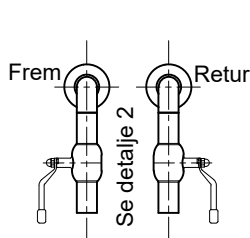

Snit B-B

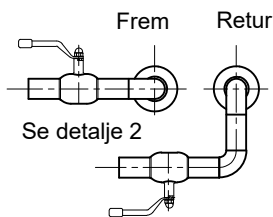

Snit C-C

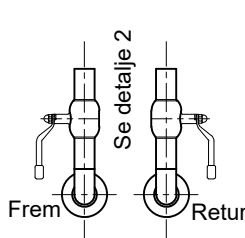

Snit D-D

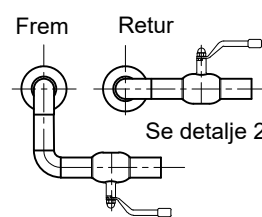

Snit E-E

Rev.	Dato	Konst./Tegn.	Kontrol.	Godk.
	2016-06-01	HST/PETU	PLU	PETU
Projekt 1100009548 Mål Alle ubenævnte mål er i mm				
Tilslutningsdiagram for kundeinstallationer				
Stikindføring i kælder - Enkeltrør				
				 Grøn fjernvarme til dig Roskildevej 175, 2620 Albertslund +45 43 66 03 66 www.VEKS.dk
				Fil Tegning nr. FN-000-F-101-A